



**Angolo a quattro ante,**  
apertura ad ante scorrevoli, due fisse e due apribili. Profili superiori e verticali portanti, assenza di quelli inferiori.

**Paroi de douche d'angle,**  
ouverture par deux panneaux coulissants sur deux panneaux fixes.

**Corner shower enclosure,**  
opening with sliding panels, two fixed and two can be opened.

**Mampara de ducha angular,**  
con dos hojas fijas y dos correderas. La estructura está formada de perfiles verticales y superiores, ausencia de perfiles inferiores.

**2-tlg. Eckeinstieg,**  
2 festen Wänden und 2 Schiebetüren.

**Hoekinstap met twee schuivende panelen,**  
en twee vaste panelen.

**Четырехстворчатая угловая конструкция,**  
центральное открытие при помощи раздвижных створок: две стационарные и две открывающиеся.  
Несущие верхний и вертикальные профили, нижние отсутствуют.



H 195 cm. - V 6 mm.

# Angolo scorrevole a quattro ante

Accès d'angle



Corner shower enclosure

Angular de dos hojas correderas

2-tlg. Ekeinstieg

Hoekinstap met vier panelen

Четырехстворчатая угловая конструкция

Z [cm]	Cod.	A [cm]	B [cm]	C [cm]	 [dm <sup>3</sup> ]	 [kg]	 [n°]
70-72	B0914	31,1-33,6	36,8	39	115	28	1

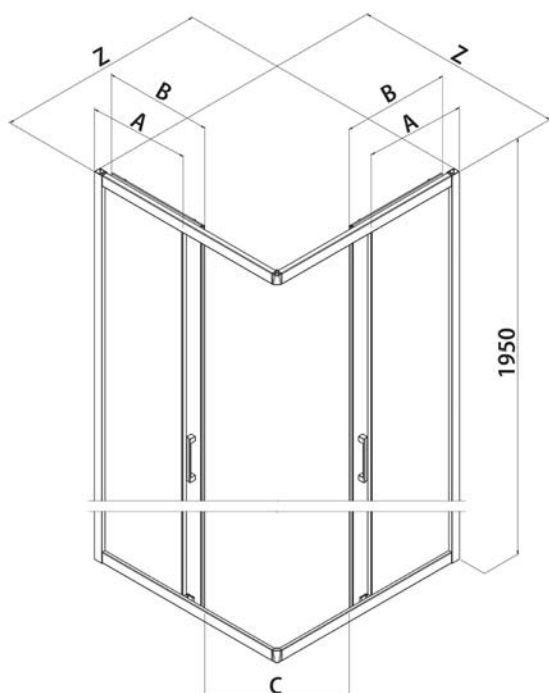

**160 mm**

Interasse maniglia  
Empattement de la poignée  
Handle wheelbase  
Distancia entre ejes de la manija  
Radstand handhaben  
Handvat wielbasis  
Колесная база ручки

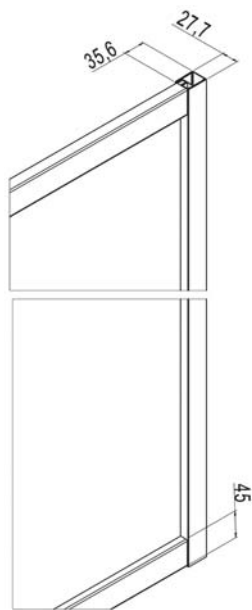
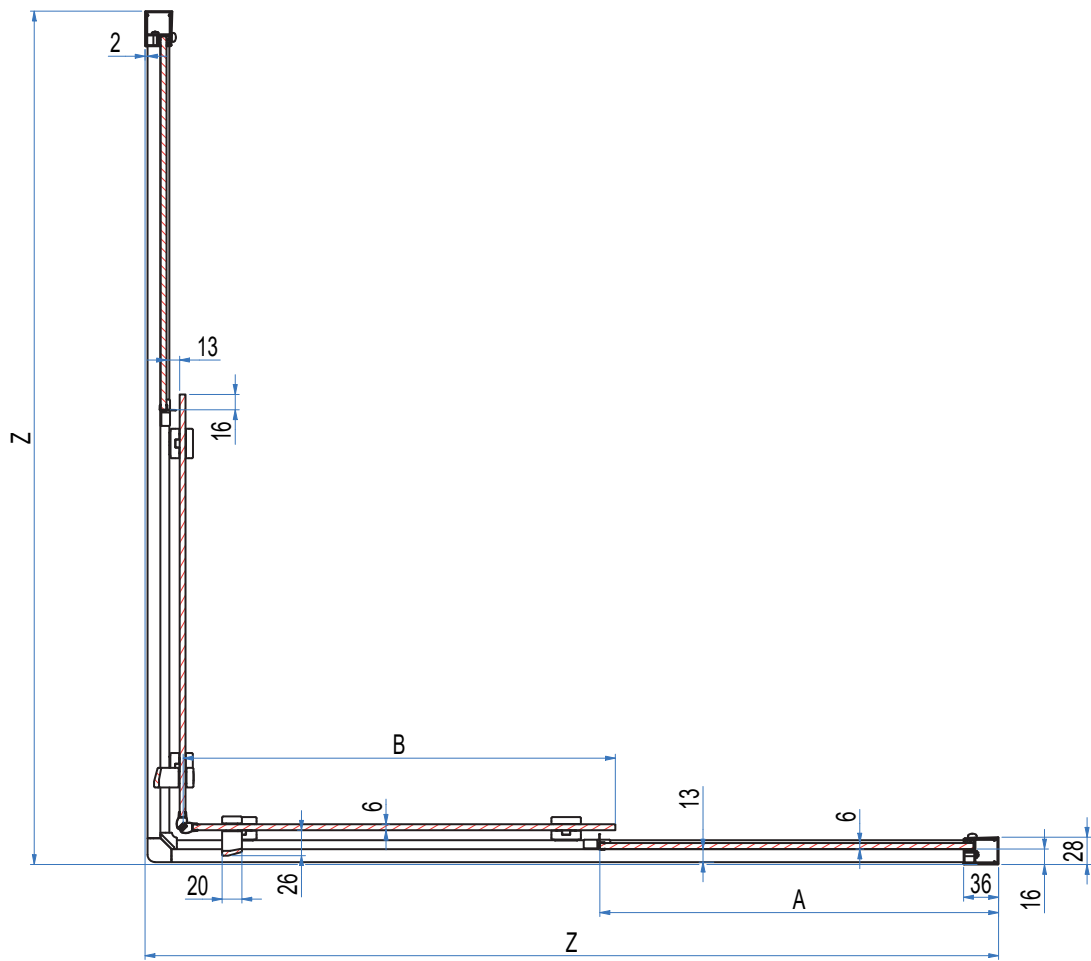

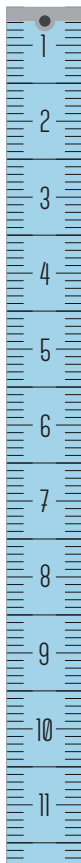

Prodotti Speciali - Produits Spéciaux - Special products - Productos Especiales - Sonderafertigungen - Maatwerk - Специальные Иродукты

MISURE LIMITE	Altezza max 200 cm.	//	Larghezza max 130 cm.	Larghezza min 50 cm.
MESURES LIMITES	Hauteur max 200 cm.	//	Largeur max 130 cm.	Largeur min 50 cm.
LIMITS OF MEASUREMENTS	Height max 200 cm.	//	Width max 130 cm.	Width min 50 cm.
MEDIDAS LIMITE	Altura max 200 cm.	//	Anchura max 130 cm.	Anchura min 50 cm.
GRENZMAßE	Höhe max 200 cm.	//	Breite max 130 cm.	Breite min 50 cm.
EXTREME MATEN	Hoogte max 200 cm.	//	Breedte max 130 cm.	Breedte min 50 cm.
ПРЕДЕЛЬНЫЕ РАЗМЕРЫ:	Макс. высота 200 см	//	Макс. ширина 130 см	Мин. ширина 50 см

	I								
	II								
	III								

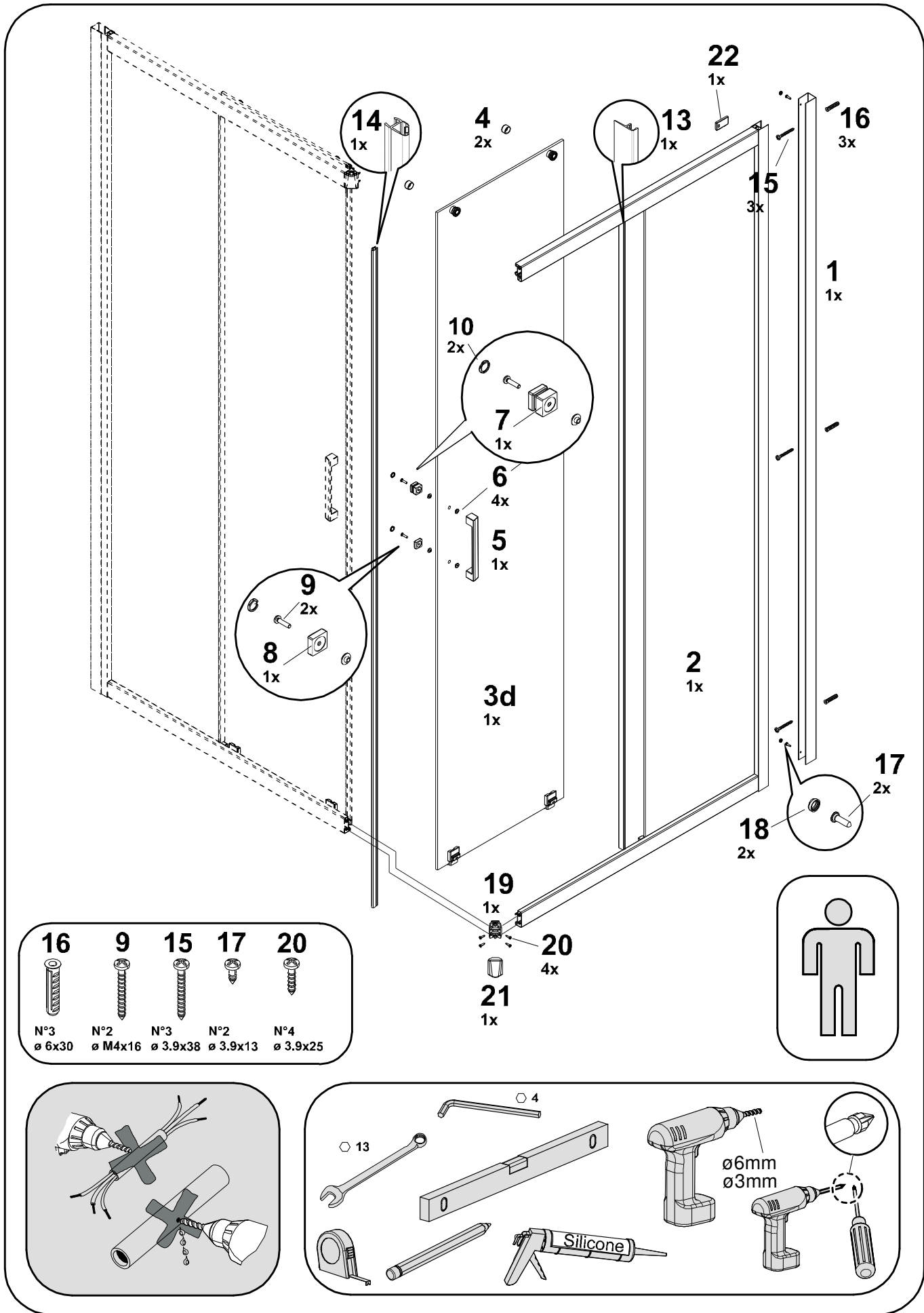

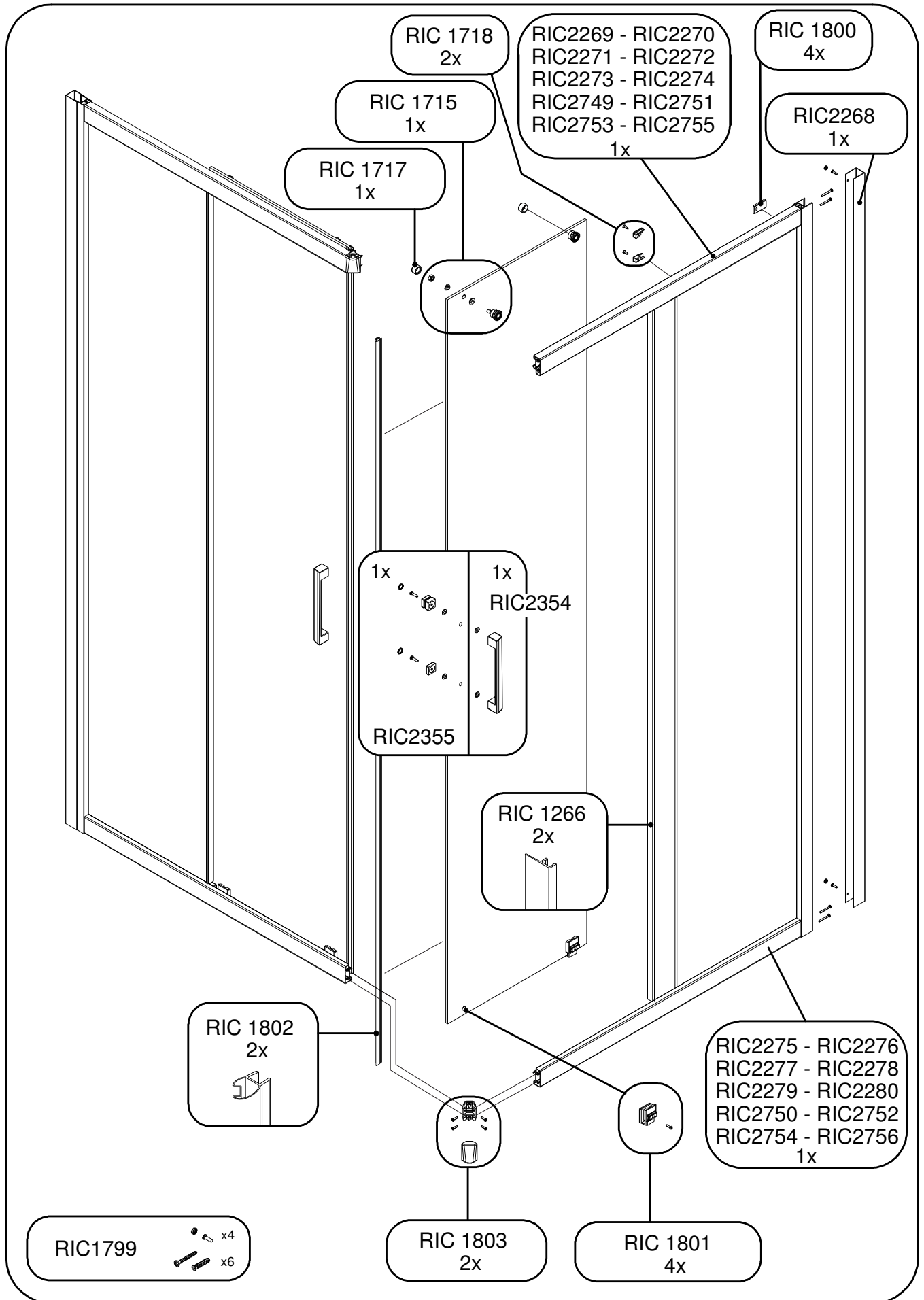

**RIC 1799**

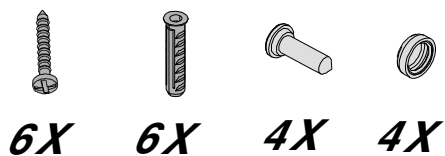

**RIC 1266**

2X

**RIC 1802**

2X

RIC 2275\_\_ - B0916  
 RIC 2276\_\_ - B0917  
 RIC 2277\_\_ - B0918  
 RIC 2278\_\_ - B0920  
 RIC 2279\_\_ - B0921  
 RIC 2280\_\_ - B0923  
 RIC 2750\_\_ - B0914  
 RIC 2752\_\_ - B0915  
 RIC 2754\_\_ - B0919  
 RIC 2756\_\_ - B0922

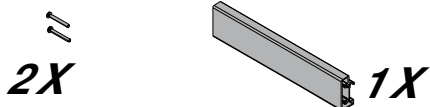

RIC 2269\_\_ - B0916  
 RIC 2270\_\_ - B0917  
 RIC 2271\_\_ - B0918  
 RIC 2272\_\_ - B0920  
 RIC 2273\_\_ - B0921  
 RIC 2274\_\_ - B0923  
 RIC 2749\_\_ - B0914  
 RIC 2751\_\_ - B0915  
 RIC 2753\_\_ - B0919  
 RIC 2755\_\_ - B0922

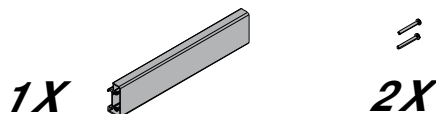

**RIC 2268**

1X

**RIC 2354**

1X  
2X

1X  
1X  
2X  
2X  
2X

**RIC 1800**

2X

**RIC 1718**

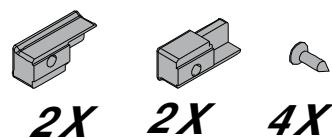

**RIC 1803**

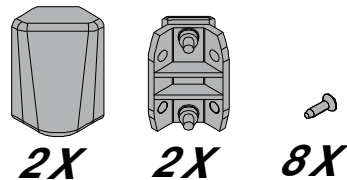

**RIC 1715**

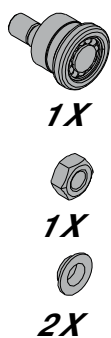

**RIC 1717**



**RIC 1801**

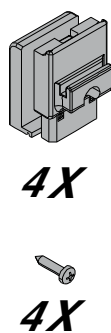

**RIC 1128**

