

Codice Dianflex: 110-16143

REMER

SCHEDA TECNICA

TECHNICAL FEATURES

RUBINETTERIE

ART. COD.

RB100S01

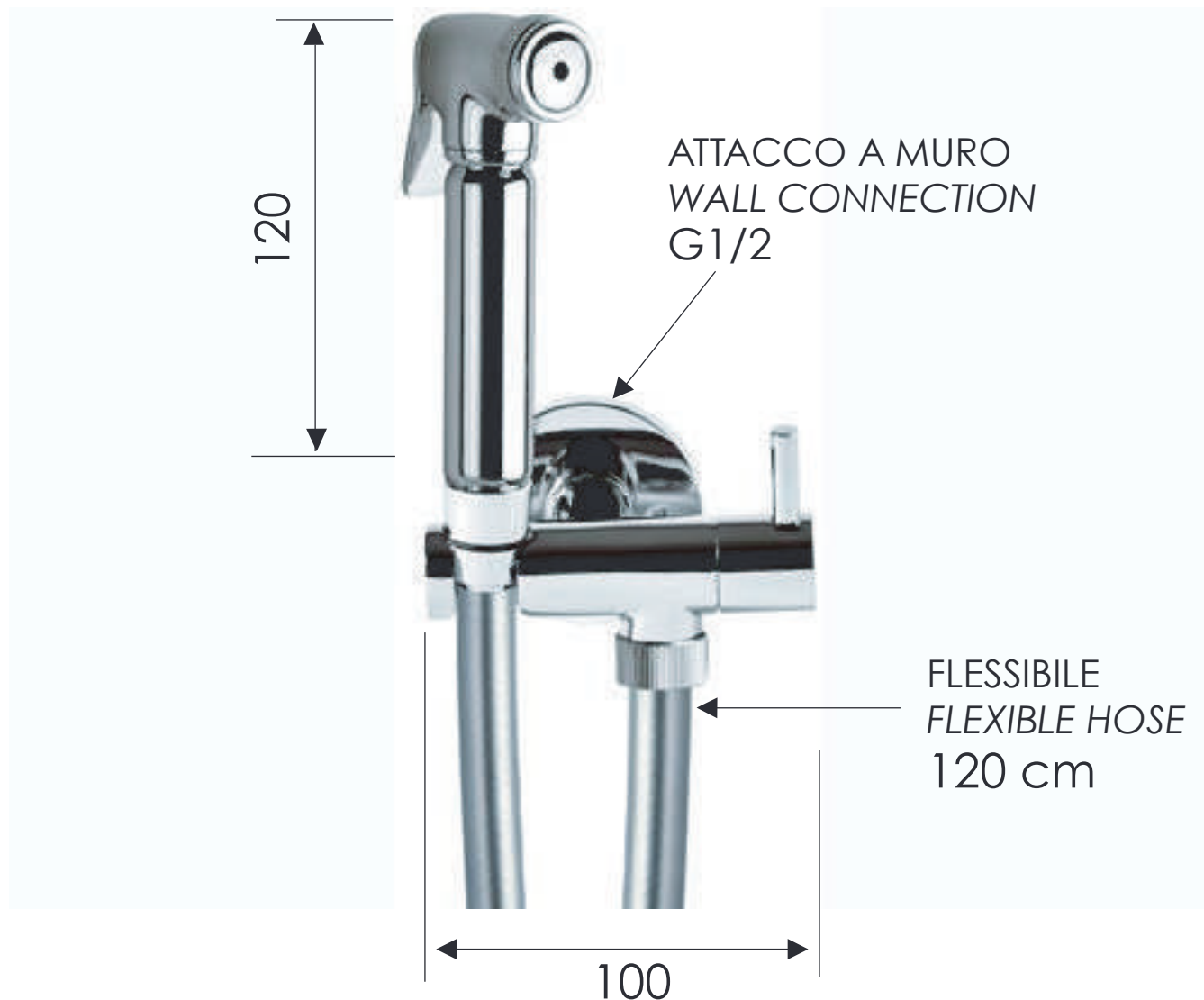

MATERIALI / MATERIALS

OTTONE CROMATO / CHROME PLATED BRASS
PVC

CROMATURA / CHROME PLATING

UNI EN 248