

Codice Dianflex: 273-H36266

DESIGN + ENGINEERING
GROHE GERMANY

Pure Freude
an Wasser



Rev. Dianflex: 01/2025

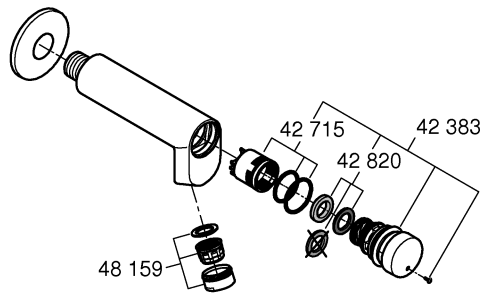
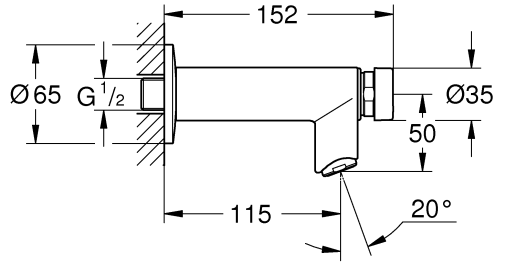

DIN
1988
DIN
EN
806

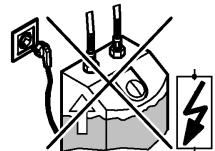
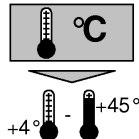
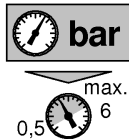
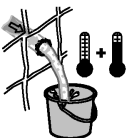

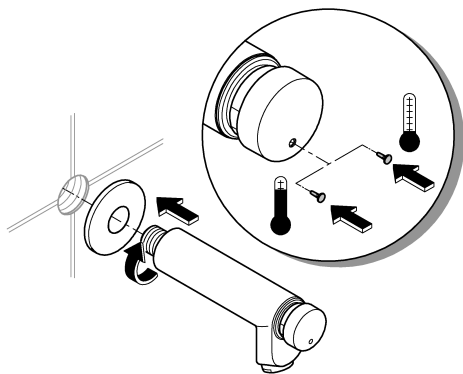

		ca. 7sec
		ca. 15sec
		ca. 30sec

