

Codice Dianflex: 320-1105-05044

A-A (1 : 1.5)

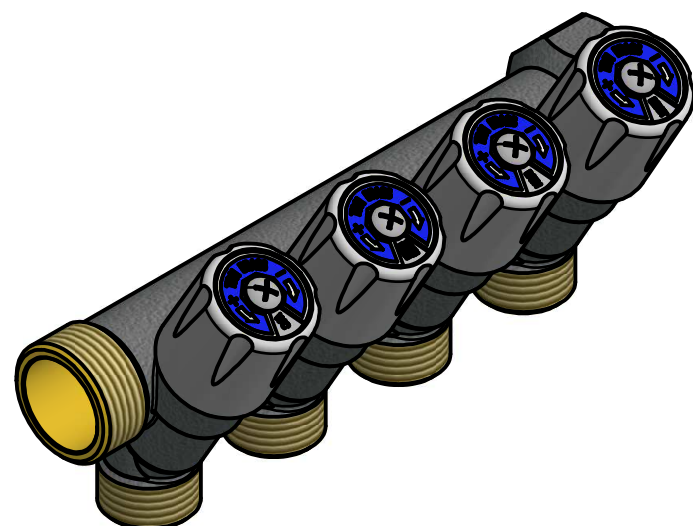
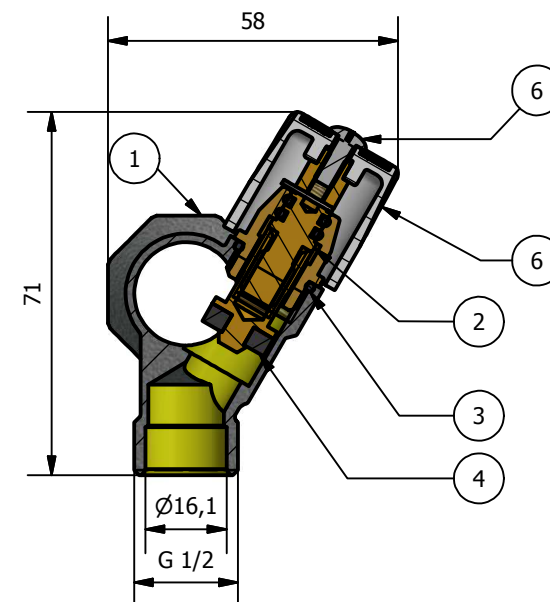
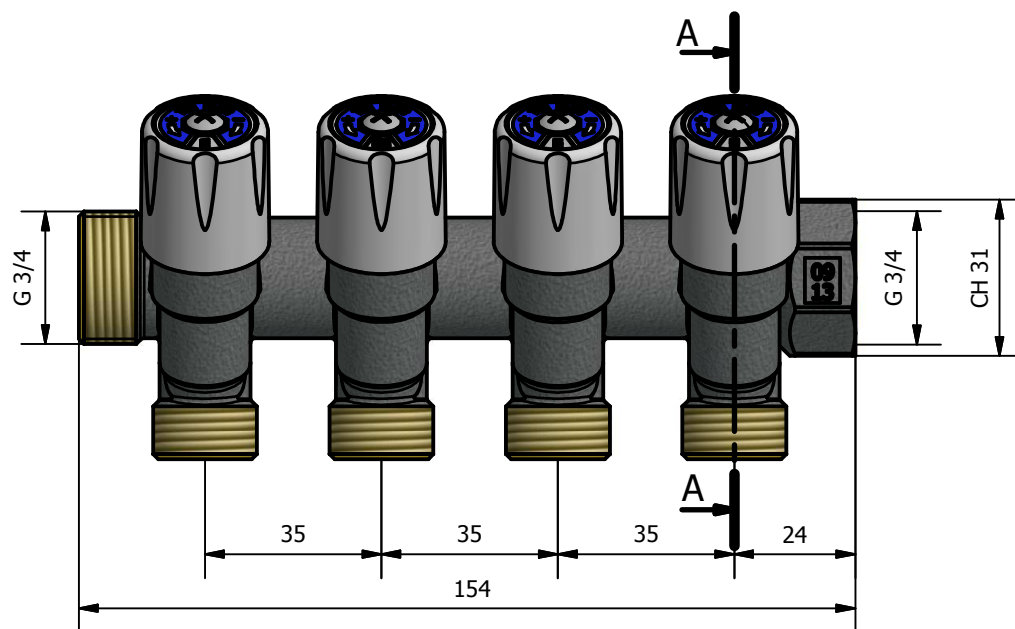

POS	DESCRIPTION	MATERIAL
1	BODY	CW617N EN12165
2	STEM	CW617N EN12164
3	O-RING	NBR 70
4	FLAT RUBBER	NBR 90
5	HANDLE	ABS (WHITE)
6	SCREW	STELL

MIN-MAX WORKING TEMPERATURE	0°C +110°C
MAX PRESSURE	10 BAR

00	Prima emissione		Delaini M.	19/06/2014
Rev.	Nota Revisione		Approvatore	Data Approvazione
Toll Gen:	JS13	Stato sup.:	Giallo Nichelato	
Filetto:	ISO 228	Note tecniche:		
Peso lavorato:	Peso grezzo:	N° stampo:	Descrizione: Manifolds with closing valve	
Materiale:		Disegnatore:	Data: 19/06/2014	
		Delaini P.		

Codice: 1105 3412 4 Scheda