

art.250/270 2-3-4-5 vie

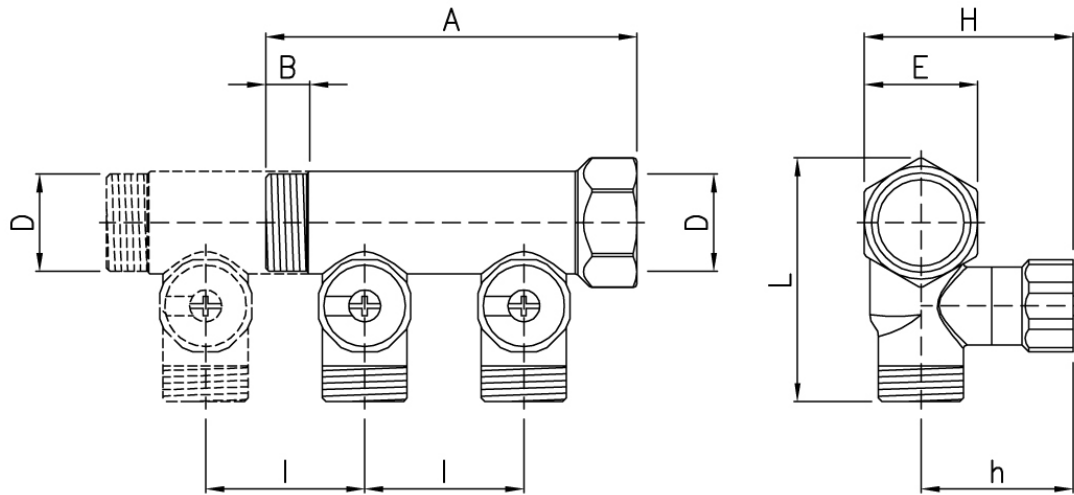

Collettori modulari a regolazione manuale.
Manual control manifolds.

Vie	D	A	B	E	H	h	l	L
2	3/4"	105	12	32	59	43	45	67
3	3/4"	150	12	32	59	43	45	67
4	3/4"	195	12	32	59	43	45	67
5	3/4"	240	12	32	59	43	45	67

Codice Dianflex: 322-2504-05

CARATTERISTICHE TECNICHE

- Pressione massima di esercizio 10 bar.
- Temperatura massima di esercizio 120° C.
- Interasse derivazioni 45 mm.
- Corpo del collettore in ottone norme UNI EN 1982 ottenuto mediante fusione.
- Vitoni in ottone norme UNI EN 12164.
- Volantino in ABS bianco RAL.
- Dischetti in alluminio serigrafato.
- Finitura: cromata.

TECHNICAL DATA

- Max operating pressure 10 bar.
- Max operating temperature 120° C.
- Centre distance 45 mm.
- Manifolds body of forged brass according to UNI EN 1982.
- Handwheel of white ABS.
- Disk spair double face.
- Chrome plated

Rev. Dianflex: 03/2025