

CIRCOLATORI

PARA

25/6 SC

CODICE DIANFLEX 412-WPAR

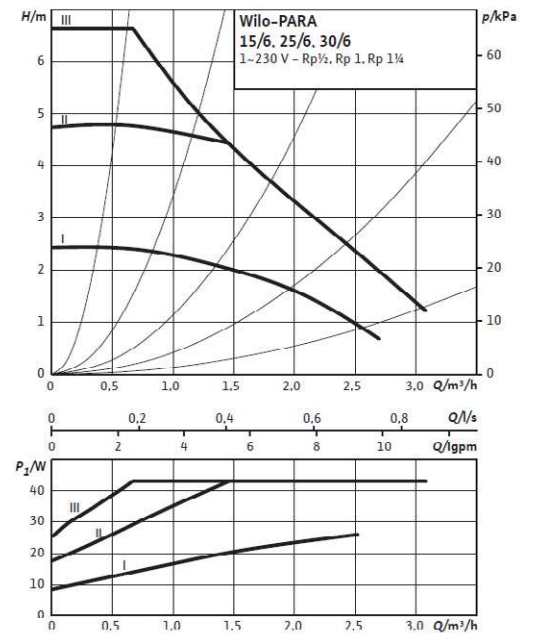
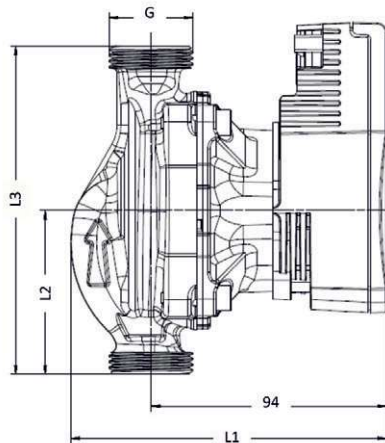
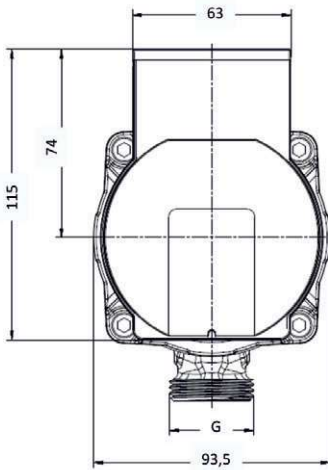
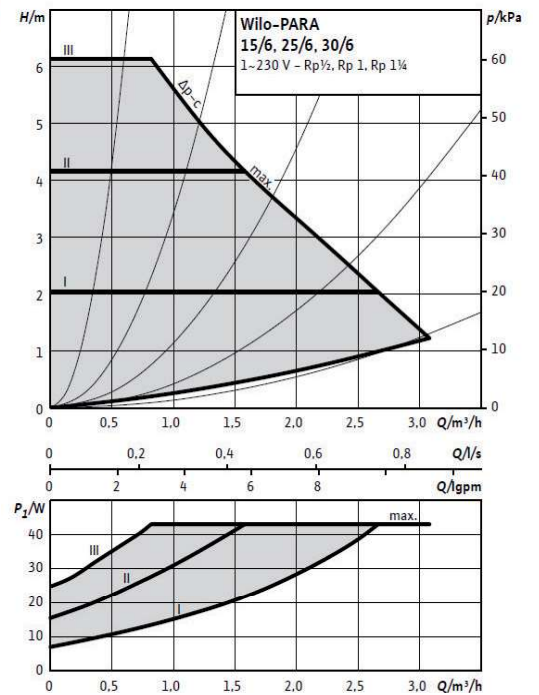
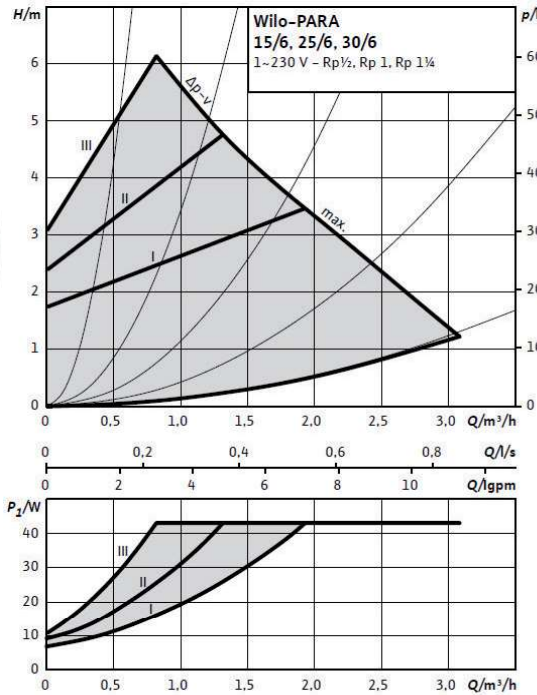

Codice	Descrizione	G	L1	L2	L3	Peso
412-WPAR-256130 101013	Para 25/6-43-SC-130-12	1" 1/2	127 mm	65 mm	130 mm	Kg 1,7
412-WPAR-256180 101016	Para 25/6-43-SC-180-12	1" 1/2	127 mm	90 mm	180 mm	Kg 1,8